

# Installation, Operating & Maintenance

## Multiport Ball Valves

### 61 & 62 Valves Series



Importer for European Union: Habonim Europe B.V. (EROI NL861781491B0)

Habonim USA 1 866 261 8400 | Habonim EU +31 79 204 0780 | Habonim Singapore +65 8127 0221 | Habonim China +86 18616808766  
Habonim Israel +972 (0) 4 691 4911 | Habonim Australia +65 8127 0221 [www.habonim.com](http://www.habonim.com)

Item number: YP0005362

REV00-05/24

## WARNINGS & SAFETY INSTRUCTIONS

Habonim cannot anticipate all the situations user may encounter while installing and using Habonim valves. The user **MUST** know and follow all applicable industry specifications on the safe installation and use of these valves.

Misapplication of the product may result in injuries or property damage. Refer to Habonim product catalogues, product brochures and installation, operating and maintenance manuals for additional product safety information or contact Habonim.

1. Always keep hands and objects away from the valve ports. Actuated valves could be accidentally operated, resulting in serious injury or valve damage.
2. Before removing a valve from the line, always make sure the line has been depressurized and drained. Cycle the valve a few times to relieve any pressure that could be trapped in the body cavity.
3. Utmost caution must be taken when handling a valve that has toxic, corrosive, flammable, or a contaminant nature media flowing through its pipeline. The following safety precautions are recommended when dismantling valves with hazardous media:
  - 3.1. Wear safety glasses, protective headgear, clothing, gloves and footwear.
  - 3.2. Have available running water.
  - 3.3. Have a suitable fire extinguisher when media is flammable.
4. Do not try to operate a valve that exhibits any sign of leakage. Isolate the valve and either repair or replace it.
5. Do not use or substitute non Habonim components or parts in Habonim valves and assemblies.

## Three Piece Ball Valves

**Series included:**  
**61W & 62W Series**

**Sizes included:**  
**1/4" - 4" (DN8 – DN100)**

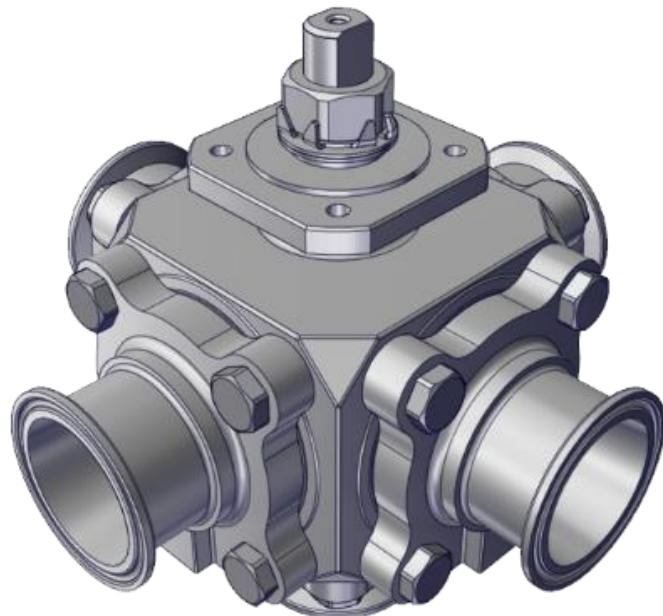

## Contents

1. General .....	3
2. SIL .....	3
3. ATEX – Explosive environment.....	3
4. Valves marking and labeling .....	4
5. Storage.....	5
6. Limitations .....	6
6.1. Erosion allowance.....	6
6.2. Lubrication and greasing.....	7
7. Installation .....	7
7.1. General .....	7
7.2. Installation of Uni-Directional valves.....	7
7.3. Installation in a vibrating environment.....	7
7.4. Flanged Valves .....	8
7.5. Installation of threaded end valves .....	8
7.6. Weld End Valves not in-line .....	8
7.7. Weld End Valves in-line - Extended Ends.....	9
8. Operating Instructions .....	9
9. Maintenance.....	10
10. Disassembly & Assembly Manual .....	11
10.1. General .....	11
10.2. Disassembly .....	11
10.3. Assembly.....	12

## 1. General

This Installation, Operating & Maintenance manual represents the instructions required for safe use of Habonim ball valve. The manual relates to reduce and full-bore valves.

Before using any of these series valves, read the entire IOM carefully and make sure everything is clear. If in doubt, please consult with Habonim.

## 2. SIL

Under severe operating conditions inspection should be more frequently; detected defects should be repaired promptly. Severe operating conditions can be defined as:

- Application temperature less or above than specified on the valve tag label.
- Flow velocity higher than 5 m/sec for liquids, and 200 m/sec for gaseous!
- Acidic media PH < 5 or alkaline media PH > 9

Habonim recommends a proof test interval of 12 months; in case of Fail to Open ESD system, a partial stroke is acceptable to confirm that the installation is functioning properly.

For ESD systems with a Fail-To-Close demand, it is necessary to plan a system shut-down; de-energize the system and inspect the valve turning to its fully closed position.

It is essential to log-in with the following parameters on site QA records.

as proof for preserving SIL capabilities: date, hour, name and signature of the responsible engineer, air pressure on site, time to close the valve, time to open the valve.

The combined corrosion and erosion allowance for the valve body wall thickness is 1 mm. When this allowance has been eroded or corroded, mechanically removed or otherwise, the valve should no longer be used. Inspect the valve wall thickness every time the valve is maintained.

The estimated mean time to repair (MTTR) a valve, i.e. time net (line draining or cooling down time excluded from the valve MTTR) of replacing old valve with a new one is 60 minutes. The maintenance team must read and understand the Habonim product IOM before starting the operation. In case of a doubt please consult the Habonim engineering team.

When a valve has been repaired or any maintenance was performed, check the valve for proper function (proof testing). Any failures affecting functional safety should be reported to the Habonim factory.

### Proof test and maintenance

During a proof test operation, all the inner soft parts (seats, seals, stem packing and bearings) to be examine and replaced (only Habonim OEM repair kits can be used!) in interval less than 5 years to claim the valve assembly "**as-good-as-new**".

Habonim recommends valve full maintenance operation every **500,000 cycles or 5 years**, whichever comes first.

Client should consult the Habonim factory to obtain the product assessment, FMEDA report, and other associated statistical data to satisfy SIL level.

## 3. ATEX – Explosive environment

The ball valves have been assessed as simple equipment within the assessment performed for the actuator. When used separately from the actuator, the ball valves shall be used within the parameters permitted for the actuator.

Habonim recommend replacing all bearings, seals, seats, and soft parts every **500,000 cycles or 5 years**, whichever comes first.

For valve actuation, actuated valves and more **ATEX** information please refer to the **Valves Actuation Assembly Guide**.

## 4. Valves marking and labeling

- 4.1. All valves marking is on a nameplate which is spot welded to the valve body.
- 4.2. Valves for the European market and above 1" carry the CE mark with the information required by the PED.
- 4.3. The valve markings that are according to API-6D standard are presented to provide the user full traceability and information regarding the valve. Unless otherwise requested, nameplates will be secured to the valve body and will be visible to the user. The information on the nameplate is as described below:

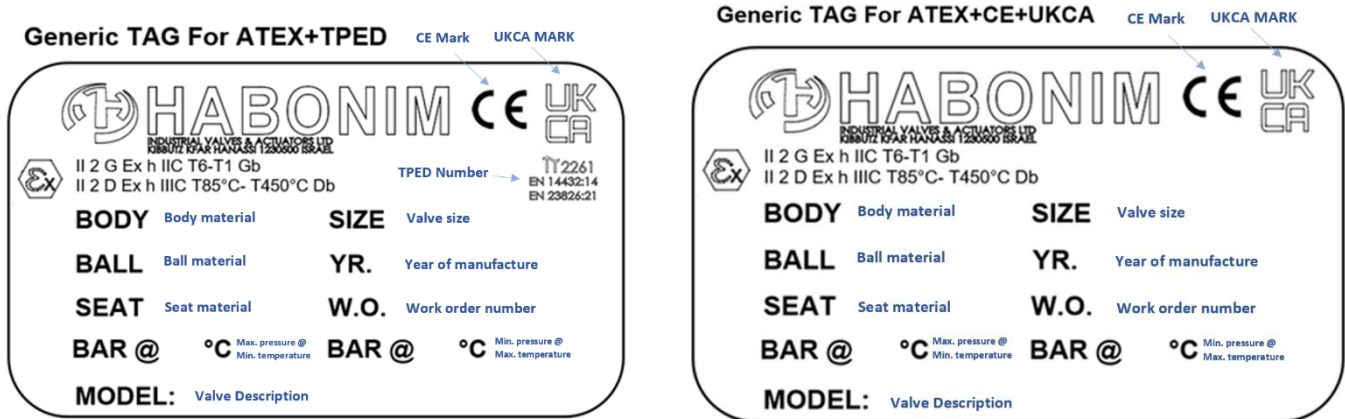

### Gas Group Protection Markings

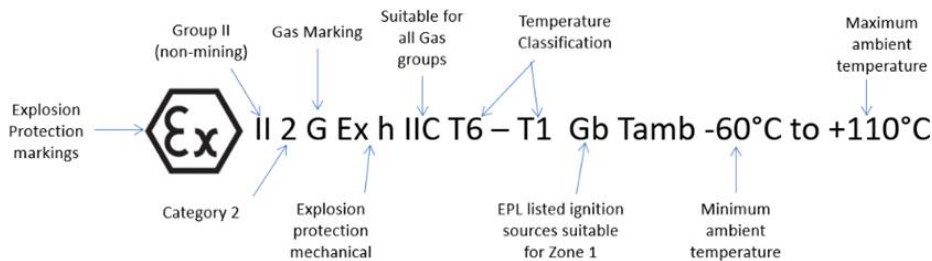

### Dust Group Protection Markings

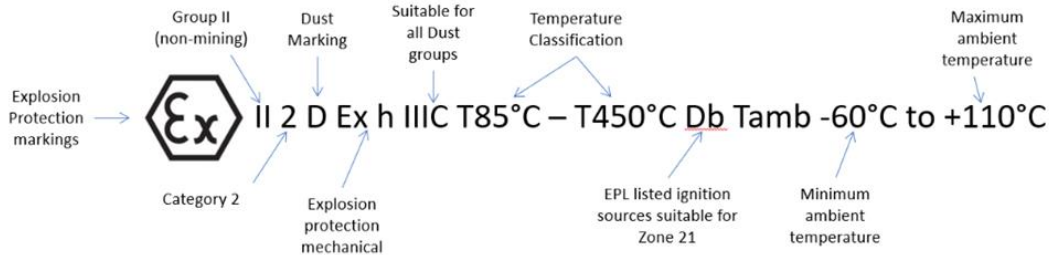

The manufacturer marks the temperature classification as T6 – T1 for Gas Group and T85°C to T450°C and the corresponding ambient temperatures. This is because the maximum surface temperature of the valves depends on the temperature of the medium (process fluid) that flows through the valve, see table below. It is therefore the responsibility of the user/installer to determine which values are applicable to their application.

Maximum Process Temperature (°C)	Associated Temperature Classification
80°C	T6 Zone 1 and T85°C Zone 21
95°C	T5 Zone 1 and T100°C Zone 21
130°C	T4 Zone 1 and T135°C Zone 21
190°C	T3 Zone 1 and T200°C Zone 21
290°C	T2 Zone 1 and T300°C Zone 21
440°C	T1 Zone 1 and T450°C Zone 21

\*Tag may be different then showed above depending on the application, region, registration etc.

**Standard API-6D Tag**

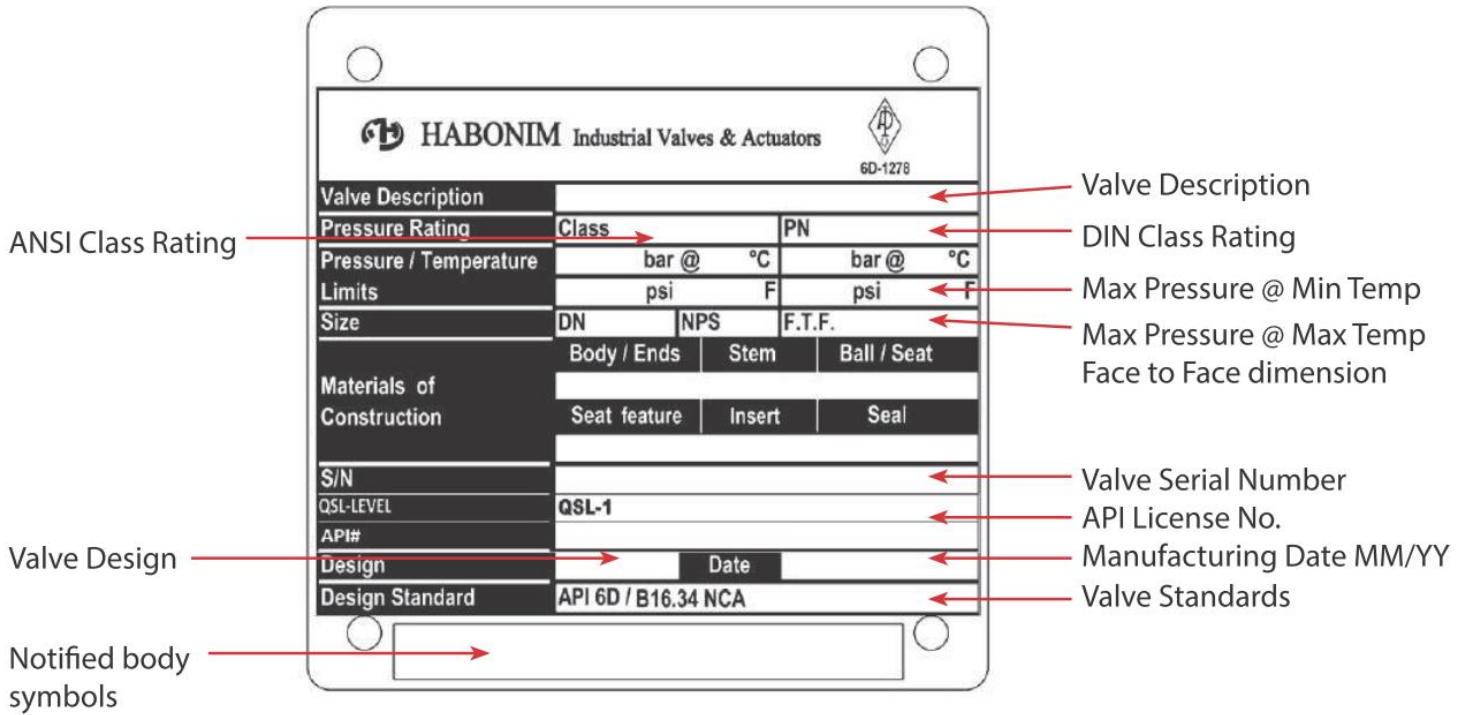

**Standard Habonim Tag**



**5. Storage**

Prior to storage, inspect the valve for shipping damage. Keep all protective packaging, flange covers, and end caps attached to the valves during storage. It is recommended to keep the valves in a clean and dry environment until they are ready for use.

Carbon Steel valves have a “black oxide” and oil dipped finish. This nontoxic process is performed to retard rusting during storage.

black oxide is not a substitute for paint or other means of protective coating to be applied to the valve once installed.

Stainless steel valves have their natural finish and do not need any additional protection once installed.

## 6. Limitations

The correct selection of materials of construction, seats and seals, internal valve components and pressure/temperature ratings determines the safe use of the valves and the performance requirements for the application.

This information can be found on the name plate welded to the valve body.

**WARNING:** DO NOT EXCEED THE VALVE PERFORMANCE LIMITATIONS! EXCEEDING THE PRESSURE OR TEMPERATURE LIMITATIONS MARKED ON THE VALVE LABEL PLATE MAY CAUSE DAMAGE AND LEAD TO UNCONTROLLED PRESSURE RELEASE, DAMAGE OR PERSONAL INJURY MAY RESULT.

**Habonim's standard valves design is for relative humidity of 50% and SATP (Standard Ambient Temperature and Pressure) environment conditions.**

It is the owner's responsibility to use the valves as recommended and in accordance with the pressure/temperature limits and chemical compatibility for both inner & outer parts as stated in this manual.

If in doubt, please consult with Habonim.

Any unstable fluid or gas should be identified by its manufacturer and must not be used with Habonim valves.

**CAUTION:** The valves should be used in a well-designed, adequately protected system to ensure that external and internal pressure and temperature limits do not exceed the valve limits. The valve rating is defined as the lower rating of the seat and valve body. Valve surface temperature may become extremely hot or cold due to operating conditions. Prevent any type of direct contact with the valve that may cause harm or injury. Avoid direct contact with the valve by wearing protective gloves. The valves should be used in a well-designed, adequately supported piping system such that it will not be subjected to undue forces, stresses, or shock loads during service. The valves are not designed to operate during or after earthquakes or under fatigue conditions.

**It is the owner responsibility to determine if fatigue conditions exist.**

Do not allow dust layers to build up on the equipment.

The process fluid temperature shall not exceed the ignition temperature of the dust.

**WARNING:** USE OF THE VALVE IS APPLICATION SPECIFIC. BE SURE THAT THE VALVE IS SUITABLE FOR ITS INTENDED SERVICE. IF YOU HAVE ANY QUESTIONS CONCERNING THE USE, APPLICATION OR COMPATIBILITY OF THE VALVE WITH THE INTENDED SERVICE, CONTACT HABONIM FOR MORE INFORMATION.

### 6.1. Erosion allowance

The combined corrosion and erosion allowance for the valve body wall thickness is **1(mm)**. When this allowance has gone, the valve should no longer be used. Inspect the valve wall thickness every time the valve is maintained.

Refer to Habonim Chemical Compatibility Chart to determine the corrosion rate for your application. As the variety of applications these valves can be used in is large, it is impossible to cover all installation and maintenance instructions for servicing the valves.

## 6.2. Lubrication and greasing

A lubricant is applied to assist valve torque break in on all Habonim valves as a standard unless specified otherwise! The lubricant, if unacceptable, may be removed by disassembling the valve, a solvent wash and assembling it back.

For lubricant removal and recommended grease please refer to the [Disassembly and Assembly chapter](#).

## 7. Installation

The installation procedure for Habonim ball valves is critical to ensuring both long life and satisfying performance. Valves stored on site, awaiting installation, should be kept in their original packaging, in dry conditions, where damage will not occur (See [storage chapter](#)).

Before carrying out the installation, it is important to follow the basic procedures described below:

### 7.1. General

- 7.1.1. It is essential to flush the line prior to assembling any valve on the line.
- 7.1.2. Carefully unpack the valve and check valve [nameplate for identification of materials](#).
- 7.1.3. Remove any special packing materials surrounding the valve.
- 7.1.4. Check the valve for the [flow direction](#) indication marks. Appropriate care must be taken to install the valve for proper flow orientation.
- 7.1.5. Inspect the valve interior through the end ports to determine it is clean and free from foreign matter.
- 7.1.6. Cycle the valve and inspect any functionally significant features.
- 7.1.7. Read all the literature and note any special warning tags or plates attached to the valve.
- 7.1.8. Before installation check to ensure that the flow line balls are in the fully open position to prevent possible damage to the ball and seats. The valve performance depends on its original conditions. At any stage do not leave the valve in the partially open position on either of the lines.
- 7.1.9. If a shut-off valve is installed for end of line service, it must be ensured that it is closed with a blind end connection and the valve is secured against being opened unintentionally.

### 7.2. Installation of Uni-Directional valves

Habonim unidirectional valves must be installed for flow in one direction as indicated by the flow arrow welded on the valve body. **Usually, the arrow points to the shutoff direction of the valve.** In case of uncertainty related to direction. Relate to the arrowhead as the low-pressure side and the arrow tail as the high-pressure side ([Fig.A](#)).

### 7.3. Installation in a vibrating environment

When installing a cryogenic valve with an actuator in a normal vibrating environment the whole unit **MUST** be fixed with a stable fixation to a rigid area.

When installing a cryogenic valve with an actuator in an **inclination angle it is CRITICAL** to do a stable fixation to the whole unit to a rigid area.

**Note: The fixation MUST be made to the top of the valve bonnet - below the actuator.**

For non-cryogenic valves it is **recommended** to do fixation in a normal vibrating environment. When installing a valve in a **high vibrating** environment such as for an off-road application - please contact Habonim.

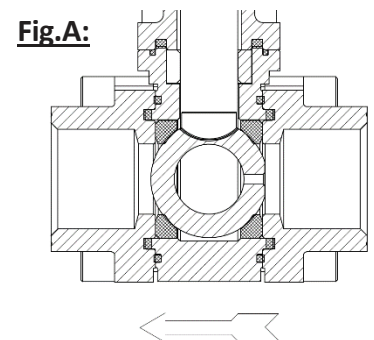

## 7.4. Flanged Valves

- 7.4.1. Before installing the valves, make sure the flanges and the pipe are free from grit, dirt or burrs.
- 7.4.2. The flanges must be aligned and parallel with the correct distance to allow the valve face-to-face dimension and gaskets to fit between.
- 7.4.3. Insert the valve between the flanges. If tilting or levering of the flanges is required, avoid harming the sealing surfaces of the flanges.
- 7.4.4. Align the valve and the pipe counter flanges and insert at least 2 bolts at the lowest side of the flange to support the gaskets.
- 7.4.5. Slide the gaskets between the flanges. Insert the remaining bolts and thread the nuts hand tight.
- 7.4.6. Before tightening the bolts, make sure the gaskets are aligned with the raised face of the flanges.
- 7.4.7. Tighten the flange bolts, with a torque value determined by the gasket manufacturer, other variables like gasket type and material, bolt, flange, and lubricant affect the tightening torque values.

**IMPORTANT: the tightening torque selected must be high enough to ensure adequate strain (stretch) in the bolt, but not so high as to cause the material to be taken beyond yield into the plastic response region. If the initial bolt stress is too low the total amount of strain (stretch in the bolt) is low and under these circumstances any subsequent reduction in thickness of the gasket due to creep will quickly result in loss of bolt strain and subsequent leakage.**

- 7.4.8. It is recommended to use ring spanners to tighten and support the bolts and nuts.
- 7.4.9. **Note:** bolts tightening must be uniform in order to create a parallel movement of the two flanges and uniform deformation of the gasket in between them.
- 7.4.10. Before flushing the line, be sure the valves are in the fully open position. Fail-to-close actuated valves should be operated to the open position for flushing.
- 7.4.11. Before pressure testing the valves, bring the valves to the half open position to ensure pressure reaches the stem seals and to avoid unnecessary loading of the seats. Fail-to-close actuated valves should be brought to the half-open position.

## 7.5. Installation of threaded end valves

- 7.5.1. Valves with threaded ends should be treated as a single unit and should not be dismantled when installed to pipeline.
- 7.5.2. Before installing the valves, make sure that the threads on the mating pipe are free from excessive grit, dirt, or burrs.
- 7.5.3. When tightening the valve, apply a pipe wrench or spanner to the end connector closest to the pipe being worked, using standard piping practices.
- 7.5.4. Use appropriate joining sealants material in correct quantities.
- 7.5.5. If “back-welding” is required on threaded end valves, refer to the instructions for Weld End valves or to the “Habonim Welding Instructions” bulletin.

## 7.6. Weld End Valves not in-line

- 7.6.1. Welding instructions for non-line valves are supplied in the valve package. For more information on recommended welding procedures or seat materials, please consult with Habonim.

## 7.7. Weld End Valves in-line - Extended Ends

- 7.7.1. Welding of valves shall be performed by a qualified person according to the ASME Boiler Construction Code Section IX. For valves to be welded within the EEA, refer to the requirements of ESR 3.1.2 of the Pressure Equipment Directive 97/23/EC.
- 7.7.2. Valves that will be welded directly to the line must be in the fully open position to protect the ball and seats from excessive temperatures during the welding procedures.
- 7.7.3. It is recommended to remove the valve wrench during the welding procedure. Protect or remove actuators from weld splatter or arc strikes. Valves in the "Fail Close" position should be cycled to the open position.
- 7.7.4. Use a temperature stick and a wet cloth wrapped around the center section to prevent overheating.

**WARNING: DO NOT heat the center section over 150°C (300°F).**

- 7.7.5. Align valve to pipeline, ensuring proper fit to minimize pipe load. Tack weld only.
- 7.7.6. Complete welding in small segments. Allow enough time for cooling between each segment.
- 7.7.7. After completing the welding, wait for the valve to cool below 90°C (200°F).
- 7.7.8. Replace the wrench or actuator. It is recommended not to rotate the valve to the closed position before flushing the line.

**Note: There is no need to replace the seals for valves with extended ends**

**WARNING: Valves with soft part seats that have temperature limit less than 150°C (Delrin® & UHMWPE) seats must be disassembled before welding in line and welded in the same method as not in-line valves. For more information on recommended welding procedures or seat materials, please consult with Habonim.**

## 8. Operating Instructions

Habonim Valves provide tight shut off when used under normal conditions and in accordance with Habonim's published pressure/temperature chart.

Habonim valves are designed to work only in a fully open or closed position. If the application requires to operate the valve in a partially open (throttled) position, please consult with Habonim!

**WARNING: If these valves are used in a partially open (throttled) position, seat life may be reduced. Damage may occur to the seats which may lead to valve leakage.**

On manual operated valves, the valve operation is done by turning the valve handle 90° counterclockwise to open (handle is parallel to flow line), and 90° clockwise to close (handle is perpendicular to flow line).

**WARNING: Never look into the valve bore while the valve is in a flow line. Pressure and fluids could escape from the valve causing harm or injury.**

## 9. Maintenance

HABONIM valves have a long and reliable life, and maintenance is seldom required. When maintenance is necessary, valves can be refurbished on site.

Habonim recommend replacing all bearings, seals, seats, and soft parts every **500,000 cycles or 5 years**, whichever comes first.

To extend valve performance and reduce possible plant problems, the following procedures should be followed:

- 9.1. If leakage around the stem is noticed, check the stem nut torque according to value in Table 1 in the Disassembly and assembly manual. If the leak continues, tighten the gland nut about a 1/4-turn as a routine maintenance procedure. This will compensate for any wear or settling of the gland packing.

**Caution: Excessive tightening of the stem nut can result in accelerated seal wear and high valve operating torque.**

- 9.2. It is **strongly recommended** to tighten the stem nut torque according to value in Table 1 in the Disassembly and assembly manual every 15,000 cycles.

**IMPORTANT: Up to 4 stem tightening operations every 15,000 cycles and 60,000 cycles in total are permitted.**

**Afterwards, all stem packing seals replacement is required (items 7,7a,9 and 10a) following the instructions in the disassembly and assembly manual.**

- 9.3. If the valve is removed from the line and disassembled, replacement of all seats and seals is **required** by using the appropriate Habonim Repair kit. Examine all metallic sealing surfaces such as ball, stem, and the surfaces on the end connectors that contact the seats for wear, corrosion, or damage.
- 9.4. Only Habonim authorized spare parts should be used. Default repair kit parts from Habonim can be found at "components & materials" in Habonim catalog.
- 9.5. In addition to repair kits, other spare parts are available from Habonim, such as the stem, glands, bolts, screws, and nuts.
- 9.6. Should additional parts be required, it is recommended that the complete valve be replaced.
- 9.7. When ordering repair kits, please provide the valve size and full figure number code and series, engraved on the valve ID tag.

**To prevent leakage, malfunctions resulting from internal wear or seal degradation, the user must establish a preventive maintenance and inspection program. This program must include:**

1. Inspection of parts to detect loss of wall thickness which may result in decreased pressure capacity (see Para. "Limitations" - for acceptable reduction of wall thickness).
2. Routine replacement of seals and inspection for proper operation.

**Valve operating torques, as published in the Habonim literature, are the normal expected maximum break-out torques. These torques have been confirmed by laboratory testing of each valve under controlled conditions. Highly viscous or abrasive media, frequency of operation and temperature fluctuations could cause an increase in valve torque.**

## 10. Disassembly & Assembly Manual

### 10.1. General

- 10.1.1. It is strongly recommended to review both the disassembly and assembly chapters before getting started.
- 10.1.2. For full bore valves, use one size up to your valve size when using the torque tables.
- 10.1.3. For any discrepancies, please contact Habonim.
- 10.1.4. Habonim recommends using lubricants as in the **Lubricants Table** or any equivalent.

#### **Lubricants Table:**

Valve/Application	Lubricant Type	Service
Standard Applications Valves	MOLYKOTE 33 (Medium)	Seats, Body Seals and Stem
	MOLYKOTE DX	Bolts
Clean applications Valves (Such as: Oxygen "O" & Hydrogen "H")	MOLYKOTE BG 87 Or HP-870	Stem seals, thrusts, seats, ball, and bolts.

**WARNING: Only lubricants that are compatible with the media and the valve may be applied.**

### 10.2. Disassembly

- 10.2.1. Cycle the valve with the line pressure fully relieved before attempting to remove the valve from the pipeline, to ensure pressure has also been discharged from the valve cavity.
- 10.2.2. Set the valve to an open position.
- 10.2.3. Remove the body bolts.
- 10.2.4. Carefully separate the ends from the valve body and pull the center section from the line.

**WARNING: Be careful not to damage the tongue and groove (Fig.1)**

- 10.2.5. Remove and discard the seats, body seals and all the valve parts.

**WARNING: Be careful not to damage the sealing surfaces.**

- 10.2.6. Set the valve to a close position.
- 10.2.7. Support the ball to prevent it from falling out of the valve body and set the ball aside in a clean secure area for reuse.
- 10.2.8. Remove stem nut and all the stem assembly components. Place all the removed components, in a clean and secure area.
- 10.2.9. Push the stem down into the valve body and remove it.
- 10.2.10. Discard the stem thrust seals, care taken not to scratch or nick the stem bore area of the body.
- 10.2.11. Clean the stem and the stem bore area.

**Fig.1:**

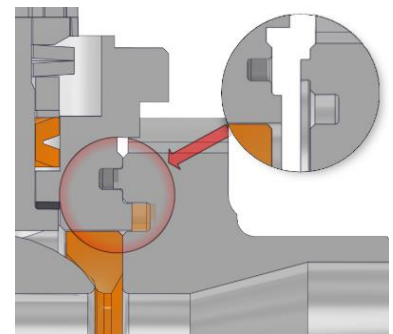

### 10.3. Assembly

The following instructions are for valves of all sizes.

- 10.3.1. Lubricate the stem thrust seal (7) and the stem seal (9) with appropriate lubricant.
- 10.3.2. Place the stem thrust seal (7) on the stem (4).

**WARNING: For valves size 3" and above verify that the thrust seal chamfer faces down (Fig.2).**

- 10.3.3. Insert the stem (4) horizontally into the valve body (1) with the threaded side first and carefully guide it up through the stem bore.

#### Stem for valve sizes 1/4" to 1.5" (DN8 – DN38)

- 10.3.4. Holding the stem (4) up insert the stem seal (9) over the stem (4) and into the stem bore. Place the anti-abrasion ring (7A\*), place the O-ring (22\*\*) into the follower (10), slide bearing (10A), two-disc springs (11), and Thread the stem nut (12) onto the stem (4)
- 10.3.5. Tighten the stem nut onto the stem according to **table 1**.
- 10.3.6. Add the tab lock washer (13) after tightening the stem nut.

**Note: For bare shaft valves sizes 1/2" (reduce and full bore) and 3/4" (reduce) the top stem nut (12) is for shipment propose only and must be disassembled before actuator assembly.**

#### Stem for valve sizes 2.5" to 4" (DN50 – DN100)

- 10.3.7. Holding the stem (4) up insert the stem seal (9) over the stem and into the stem bore. Place the anti-abrasion ring (7A), slide bearing, O-ring support (10B\*\*\*), O-ring (22\*\*), follower (10), two-disc springs (11), location ring (13A), locking clip (13) and thread the stem nut onto the stem
- 10.3.8. Bend the locking clip washer (13) across the stem nut after tightening it.
- 10.3.9. Tighten the stem nut onto the stem according to **table 1** and lock the locking clip.

**Table 1:**

Valve Size	Stem Size	Stem Thread	HERMETIX	
			N-m	Lb-In
1/4"-1 1/4"	1"	7/16"- 20 UNF	11	97
1 1/2"	1 1/2"	9/16"- 18 UNF	15	133
2"-2.5"	2.5"	M20x2.5 – 6G	30	265
3"-4"	3"	1" - 14 UNS	60	530

**Fig.2:**

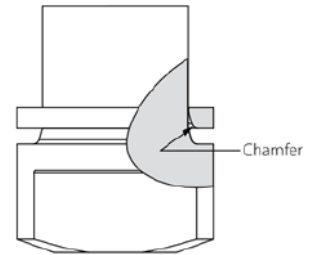

**Standard Design**

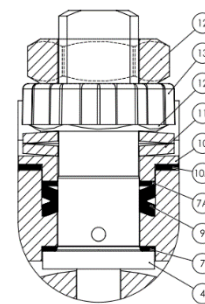

**O-Ring Design**

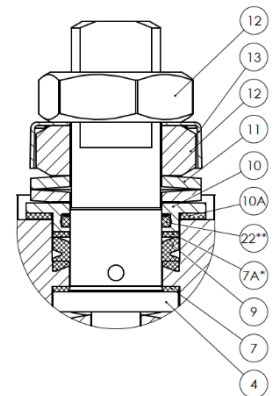

**Standard Design**

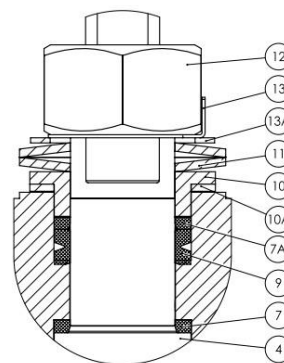

**O-Ring Design**

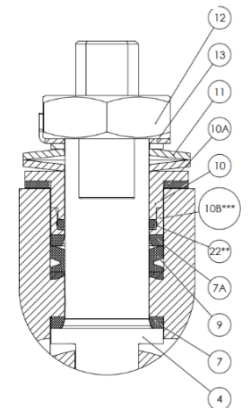

**Important: An excessively tightened stem nut can cause excessive packing wear and increase stem torque.**

\*For valves with O-ring (22), available only for size 1.5" and above  
 \*\* Available only for the O-ring design.  
 \*\*\*Available only for valves with O-ring (22) design.

**Handles for valve sizes 1/4" to 1.5" (DN8–DN38)**

10.3.10. Holding the stem (4) up insert the stem seal (9) over the stem

(4) and into the stem bore. Place the anti-abrasion ring (7A), follower (10), slide bearing (10A), two-disc springs (11), and Thread the stem nut (12) onto the stem (4).

10.3.11. Tighten the stem nut onto the stem according to **table 1**.

10.3.12. Add the tab lock washer (13).

10.3.13. Place the handle (14) on the top of the tab lock washer.

10.3.14. Place the serrated washer (15) and tighten the handle nut (12) onto the stem according to **table 1**.

10.3.15. Thread the stop pin (8).

Standard Design

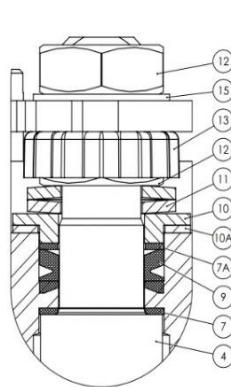

O-Ring Design

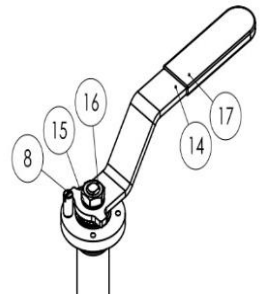
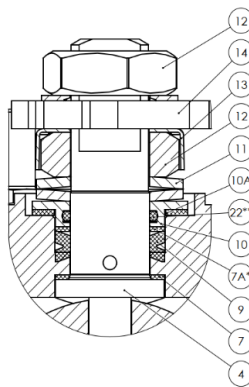

**Handles for valve sizes 2" to 4" (DN50 - DN100)**

10.3.16. Holding the stem (4) up insert the stem seal (9) over the stem and into the stem bore. Place the anti-abrasion ring (7A), slide bearing (10A), follower (10), stop plate (14A), locking clip (13) and thread the stem nut onto the stem.

10.3.17. Tighten the stem nut onto the stem according to **table 1**.

10.3.18. Bend the locking clip washer (13) across the stem nut.

10.3.19. Insert the handle (14) into the wrench head (14B).

10.3.20. Place the wrench head on the top of the stem and tighten the wrench bolt (16).

10.3.21. Place the stop pin washer (8A) and thread the stop pin (8).

Standard Design

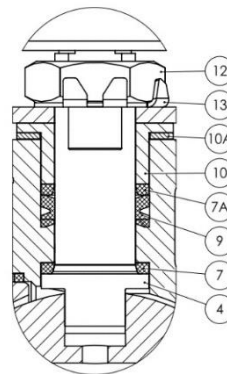

O-Ring Design

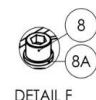
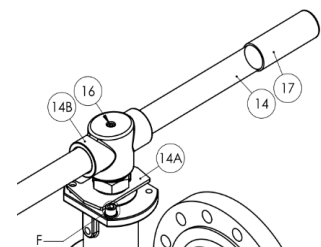
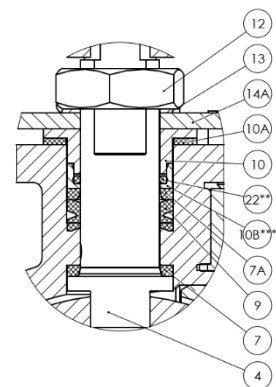

\*For valves with O-ring (22), available only for size 1.5" and above  
 \*\* Available only for the O-ring design.  
 \*\*\*Available only for valves with O-ring (22) design.

**The following instructions are for off-line assembly of valves all sizes**

- 10.3.22. Place the seat (5) into the support seat (5B) and insert the assembled support seat into the back of the valve body (1) (Fig.3-61 Valves).
- 10.3.23. Bring the valve to the close position and insert the ball (3).
- 10.3.24. Place the ball in the valve body (1) until the stem tongue is engaged and turn the stem so the valve is at an open position to prevent the ball from falling out.
- 10.3.25. Lubricate the ball and seats with appropriate grease.

**Fig.3:**



**NOTE: If in - line greasing is not allowed, the greasing of the ball and seats can be waived.**

- 10.3.26. Insert the seats (5) into the seats housing (5A).
- 10.3.27. On the seats housing place, the body seals (6) and the seat seals (5B).
- 10.3.28. Place the assembled seats housing into the valve body (Fig.4-62 Valves).
- 10.3.29. Insert the outer body seals (6B) into the valve ends.
- 10.3.30. To prevent galling of threads of the bolts or nuts, lubricate threads with an anti-galling compound.
- 10.3.31. Ease back the body assembly between end connectors (2), taking care not to score faces or damage seals, and reinstall body bolts (18).
- 10.3.32. Apply initial tightening of the body bolts according to tightening sequence as illustrated:

**Fig.4:**

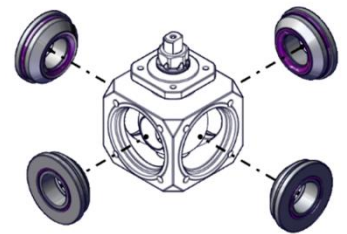

**Tighten Pattern:**

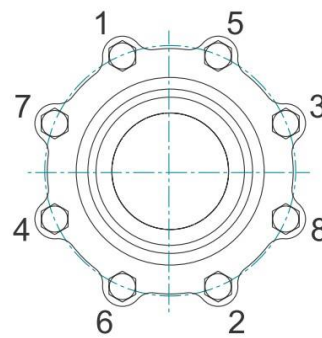
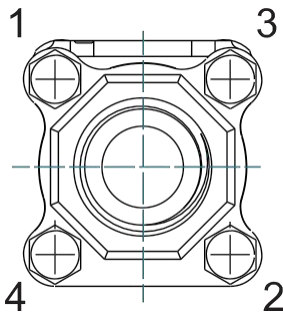

- 10.3.33. Tighten the body bolts according to table 2:

**Table 2:**

Bolt material	Thread	Valve size	Required torque	
			N-m	Lb-in
Stainless Steel: Grade A2-70 Grade A4-80	M8	1/4"-3/4"	20	180
	M10	1" - 1 1/4 "	40	350
	M12	1 1/2" - 4"	65	575

- 10.3.34. Set the valve to the wanted flow pattern.

**61W** **62W** ½"-1½" | DN15-DN40 | CLASS 600\*



## Multiport Floating Ball

Components & materials

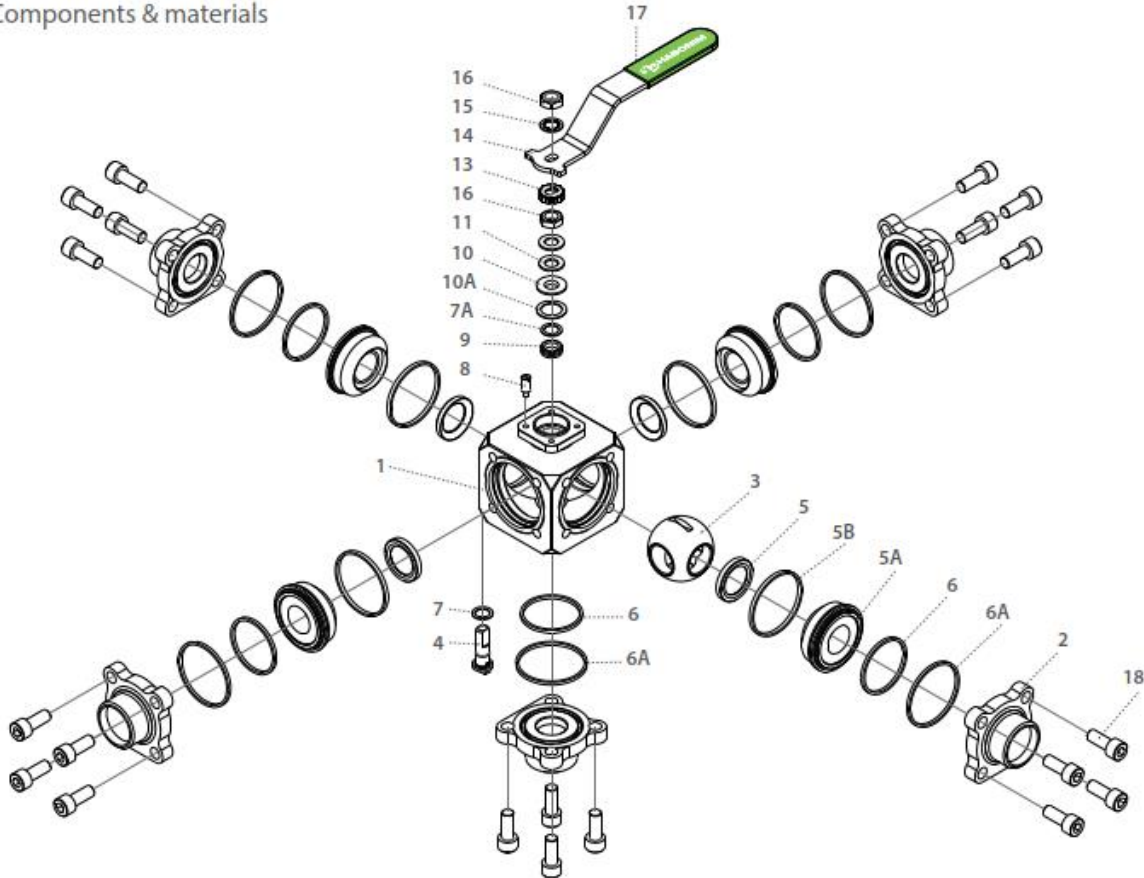

Item	Description	Material specification	Qty.
1	Body	Acc. Ordering Code	1
2	Ends	Acc. Ordering Code	5
3	Ball	Acc. Ordering Code	1
4	Stem	Acc. Ordering Code	1
5*	Seat	Acc. Ordering Code	4
5A	Support Seat	Acc. Ordering Code	4
5B*	Seat Seal	Acc. Ordering Code	4
6*	Inner Seal	Acc. Ordering Code	5
6A	Outer Seal	Acc. Ordering Code	5
7*	Stem Thrust Seal	PEEK, CF PEEK, PCTFE	1
7A	Anti-Abrasion Ring	PEEK, CF PEEK, PCTFE	1
8	Stop Pin	S. Steel	1

Item	Description	Material specification	Qty.
9*	Stem Seal	CF PTFE,TFM	1
10	Follower	S. Steel	1
10A	Slide Braring	S. Steel	1
11	Disc Spring	S. Steel	2
12	Stem Nut	S. Steel	1
13	Locking Clip	S. Steel	1
14	Handle	S. Steel	1
15	Serrated Washer	S. Steel	1
16	Handle Nut	S. Steel	1
17	Sleeve	PVC	1
18	Body Bolts	S. Steel	20

\* Repair kit components

\* ½" Full Bore

61W 62W 2"-2½" | DN50-DN65 | CLASS 300



## Multiport Floating Ball

### Components & materials

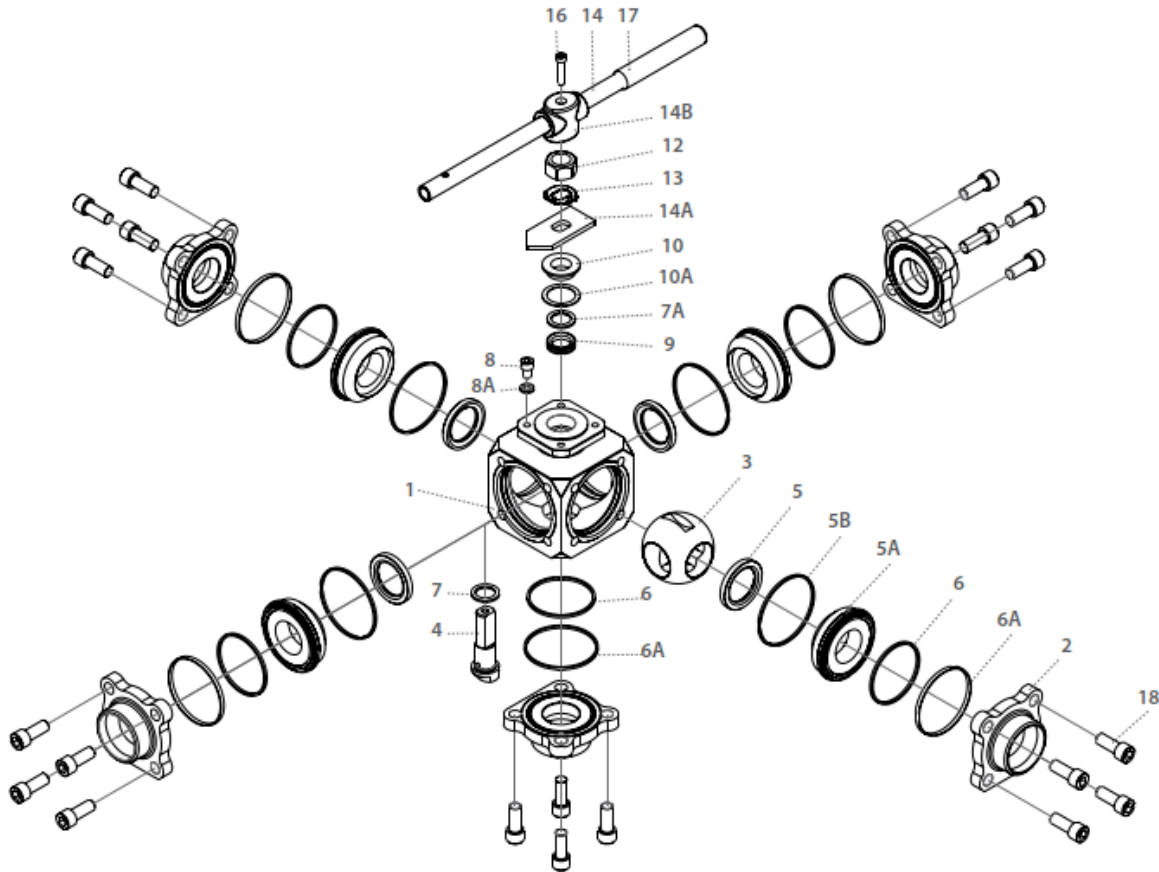

Item	Description	Material specification	Qty.	Item	Description	Material specification	Qty.
1	Body	Acc. Ordering Code	1	8A	Spring Washer	S. Steel	1
2	Ends	Acc. Ordering Code	5	9	Stem Seal	CF PTFE,TFM	1
3	Ball	Acc. Ordering Code	1	10	Follower	S. Steel	1
4	Stem	Acc. Ordering Code	1	10A	Slide Bearing	S. Steel	1
5	Seat	Acc. Ordering Code	4	12	Stem Nut	S. Steel	1
5A	Support Seat	Acc. Ordering Code	4	13	Locking Clip	S. Steel	1
5B	Seat Seal	Acc. Ordering Code	4	14	Handle	S. Steel	1
6	Inner Seal	Acc. Ordering Code	5	14A	Stop Plate	S. Steel	1
6A	Outer Seal	Acc. Ordering Code	5	14B	Wrench Bolt	S. Steel	1
7	Stem Thrust Seal	V. PEEK, CF PEEK, PCTFE	1	16	Handle Nut	S. Steel	1
7A	Anti-Abrasion Ring	V. PEEK, CF PEEK, PCTFE	1	17	Sleeve	PVC	1
8	Stop Pin	S. Steel	1	18	Body Bolts	S. Steel	20

61X 62X 3"-4" | DN80-DN100 | CLASS 300



## Multiport Floating Ball

Components & materials

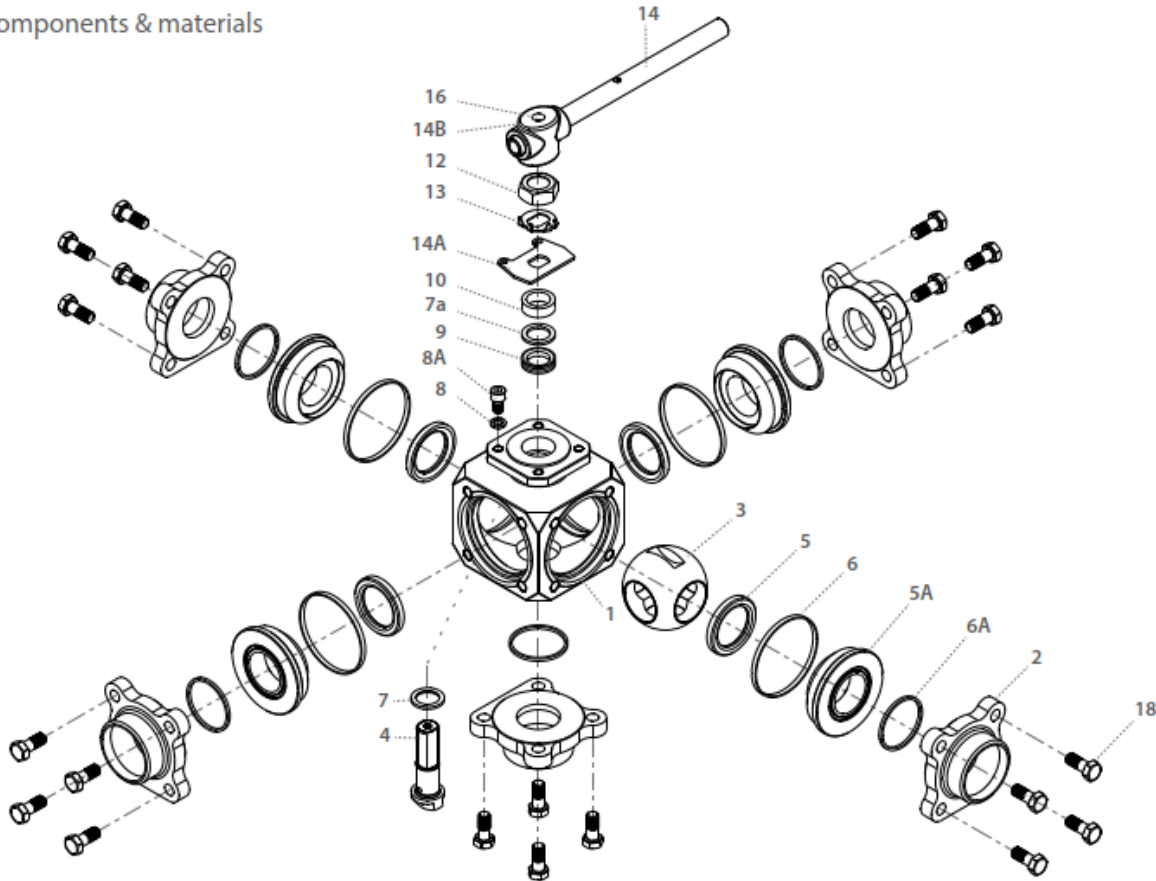

Item	Description	Material specification	Qty.
1	Body	Acc. Ordering Code	1
2	Ends	Acc. Ordering Code	4
3	Ball	Acc. Ordering Code	1
4	Stem	Acc. Ordering Code	1
5*	Seat	Acc. Ordering Code	4
5A	Support Seat	Acc. Ordering Code	4
6*	Seat Seal	Acc. Ordering Code	4
6A*	Body Seal	Acc. Ordering Code	5
7*	Stem Thrust Seal	PEEK, CF PEEK, PCTFE	1
7a	Anti-Abrasion Ring	PEEK, CF PEEK, PCTFE	1
8	Spring Washer	S. Steel	1
8A	Stop Bolts	S. Steel	1

Item	Description	Material specification	Qty.
9*	Stem Seal	CF PTFE,TFM	1
10	Follower	S. Steel	1
12	Stem Nut	S. Steel	1
13	Tab Lock Washer	S. Steel	1
14	Wrench Handle	C.St. Zinc Plate	1
14A	Stop Plate	S. Steel	1
14B	Wrench Head	S. Steel	1
16	Wrench Bolt	S. Steel	1
17	Sleeve	PVC	1
18	Body Bolt	S. Steel	20
23	Tag (not shown)	S. Steel	1

\* Repair kit components



## 3 Way Valve | Side Entry

90°	CCW ⌚				CW ⌚			
	# 001	# 002	# 003	# 004	# 005	# 006	# 007	# 008
Start								
2 <sup>nd</sup>								
180°	CCW ⌚				CW ⌚			
	# 009	# 010	# 011	# 012	# 013	# 014	# 015	# 016
Start								
2 <sup>nd</sup>								
3 <sup>rd</sup>								
360°	CCW ⌚	CW ⌚	<p>T - Horizontal</p>					
	# 017	# 018						
Start								
2 <sup>nd</sup>								
3 <sup>rd</sup>								
4 <sup>th</sup>								

### 3 Way Valve | Side Entry

90°	CCW ⌚			CW ⌚		
	# 019	# 020	# 021	# 022	# 023	# 024
Start						
2 <sup>nd</sup>						



180°	CCW ⌚		CW ⌚	
	# 025	# 026	# 027	# 028
Start				
2 <sup>nd</sup>				
3 <sup>rd</sup>				







L - Horizontal



### 3 Way Valve | Bottom Entry

90°	CCW ⌚	  <p>LL</p>
	# 029	
Start		
2 <sup>nd</sup>		

90°	CCW ⌚	  <p>L - Vertical</p>
	# 031	
Start		
2 <sup>nd</sup>		

180°	CCW ⌚	  <p>L - Vertical</p>	
	# 030		
Start			
2 <sup>nd</sup>			
3 <sup>rd</sup>			



## 4 Way Valve | Bottom Entry D61

90°	CCW ⌚				CW ⌚			
	# 032	# 033	# 034	# 035	# 036	# 037	# 038	# 039
Start								
2 <sup>nd</sup>								
180°	CCW ⌚				CW ⌚			
	# 040	# 041	# 042	# 043	# 044	# 045	# 046	# 047
Start								
2 <sup>nd</sup>								
3 <sup>rd</sup>								
360°	CCW ⌚	CW ⌚						
	# 048	# 049						
Start								
2 <sup>nd</sup>								
3 <sup>nd</sup>								
4 <sup>nd</sup>								

## 4 Way Valve | Bottom Entry D61

90°	CW ⌚ # 050
Start	
2 <sup>nd</sup>	

180°	CCW ⌚				CW ⌚			
	# 051	# 052	# 053	# 054	# 055	# 056	# 057	# 058
Start								
2 <sup>nd</sup>								
3 <sup>rd</sup>								

360°	CCW ⌚	CW ⌚
	# 059	# 060
Start		
2 <sup>nd</sup>		
3 <sup>rd</sup>		
4 <sup>nd</sup>		

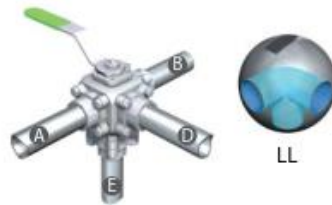



## 4 Way Valve | Bottom Entry D61

90°	CCW ⚙ # 061
Start	
2 <sup>nd</sup>	



T - Vertical

360°	CCW ⚙ # 062	CW ⚙ # 063
Start		
2 <sup>nd</sup>		
3 <sup>rd</sup>		
4 <sup>th</sup>		



L - Vertical



T - Horizontal

## 4 Way Valve | Side Entry

90°	CCW ⚙	CW ⚙	180° 2 positions	CW ⚙	180° 3 positions	CCW ⚙	CW ⚙
	# 064	# 065		# 066		# 067	# 068
Start			Start		Start		
2 <sup>nd</sup>			2 <sup>nd</sup>		2 <sup>nd</sup>		
					3 <sup>rd</sup>		

## 4 Way Valve | Side Entry

180°	CCW 
	# 069
Start	
2 <sup>nd</sup>	



L - Horizontal

360°	CCW 	CW 
	# 070	# 071
Start		
2 <sup>nd</sup>		
3 <sup>rd</sup>		
4 <sup>th</sup>		

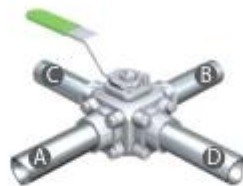

X (LL)

90°	CCW 
	# 072
Start	
2 <sup>nd</sup>	

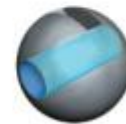

I

90°	CCW 
	# 073
Start	
2 <sup>nd</sup>	

## 5 Way Valve - Bottom Entry D62

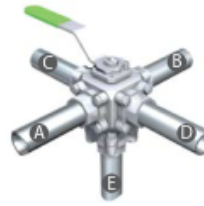

90°	CCW ◯ # 074	CW ◯ # 075
Start		
2 <sup>nd</sup>		



TT - Horizontal

180°	CCW ◯ # 076	CW ◯ # 077
Start		
2 <sup>nd</sup>		
3 <sup>rd</sup>		

360°	CCW ◯ # 078	CW ◯ # 079
Start		
2 <sup>nd</sup>		
3 <sup>rd</sup>		
4 <sup>th</sup>		

90°	CCW ◯ # 080
Start	
2 <sup>nd</sup>	

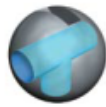

T - Vertical

360°	CCW ◯ # 081	CW ◯ # 082
Start		
2 <sup>nd</sup>		
3 <sup>rd</sup>		
4 <sup>th</sup>		



L - Vertical

180° 2 positions	CCW ◯ # 083
Start	
2 <sup>nd</sup>	

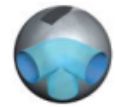

LL

360°	CCW ◯ # 084	CW ◯ # 085
Start		
2 <sup>nd</sup>		
3 <sup>rd</sup>		
4 <sup>th</sup>		