

# MULTIPORT FLOATING BALL

## Ball Types

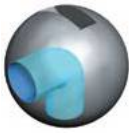

L - Horizontal



L - Vertical

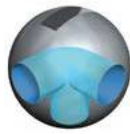

LL

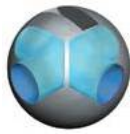

X (LL)

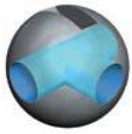

T - Horizontal

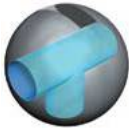

T - Vertical

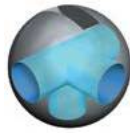

TT

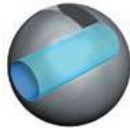

I

## Seats & body seals

The 61/62 series valves have 4 seats that provide enhanced sealing characteristics. The seats are inserted into a support ring which is sealed with 2 separate body seals - 1 seal between the support ring and the body and the other between the support ring and the end connector. Both body seals are encapsulated and thus provide tighter compression of the seal for higher

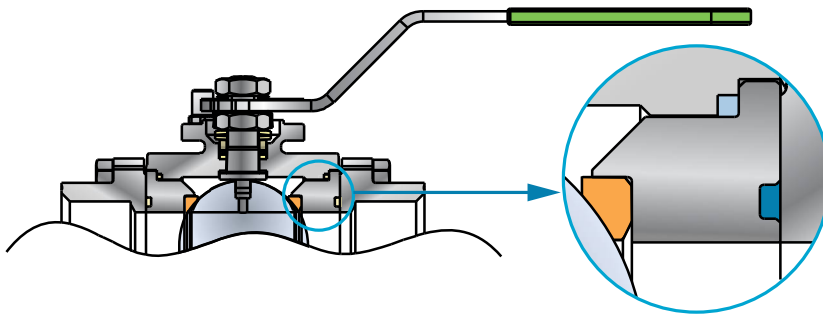

## How to Use the Valve Selection

1. Select the valve type  
3 Way Valve - Side Entry



2. Select the ball type  
T - Horizontal



3. Select the rotation angle

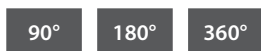

4. Select the rotation direction (ccw/cw)



5. Select the starting position and flow pattern  
Flow is indicated by a blue pipeline

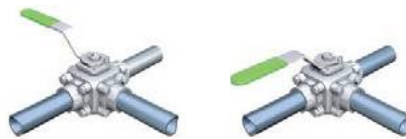

6. Use the flow pattern code number to order the appropriate valve

90°	CCW ⦿	
	# 001	# 002
Start		



# 3 Way Valve | Side Entry

90°	CCW ⦿				CW ⦿			
	# 001	# 002	# 003	# 004	# 005	# 006	# 007	# 008
Start								
2 <sup>nd</sup>								

180°	CCW ⦿				CW ⦿			
	# 009	# 010	# 011	# 012	# 013	# 014	# 015	# 016
Start								
2 <sup>nd</sup>								
3 <sup>rd</sup>								

360°	CCW ⦿	CW ⦿
	# 017	# 018
Start		
2 <sup>nd</sup>		
3 <sup>rd</sup>		
4 <sup>nd</sup>		

T - Horizontal

# MULTIPORT FLOATING BALL

## 3 Way Valve | Side Entry

90°	CCW ⌚			CW ⌚		
	# 019	# 020	# 021	# 022	# 023	# 024
Start						
2 <sup>nd</sup>						

180°	CCW ⌚		CW ⌚	
	# 025	# 026	# 027	# 028
Start				
2 <sup>nd</sup>				
3 <sup>rd</sup>				



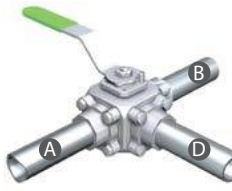

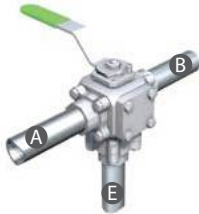
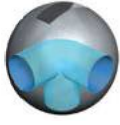

L - Horizontal

## 3 Way Valve | Bottom Entry

90°	CCW ⌚			LL
	# 029			
Start				
2 <sup>nd</sup>				

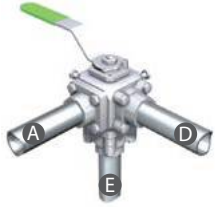
90°	CCW ⌚			L - Vertical
	# 031			
Start				
2 <sup>nd</sup>				

180°	CCW ⌚			L - Vertical
	# 030			
Start				
2 <sup>nd</sup>				
3 <sup>rd</sup>				

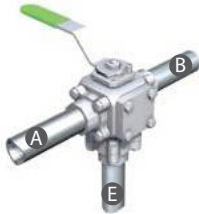
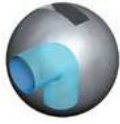

# 4 Way Valve | Bottom Entry D61

90°	CCW ◯				CW ◯			
	# 032	# 033	# 034	# 035	# 036	# 037	# 038	# 039
Start								
2 <sup>nd</sup>								
180°	CCW ◯				CW ◯			
	# 040	# 041	# 042	# 043	# 044	# 045	# 046	# 047
Start								
2 <sup>nd</sup>								
3 <sup>rd</sup>								
360°	CCW ◯	CW ◯						
	# 048	# 049						
Start								
2 <sup>nd</sup>								
3 <sup>rd</sup>								
4 <sup>th</sup>								

# MULTIPORT FLOATING BALL

## 4 Way Valve | Bottom Entry D61

90°	CW ⌚ # 050
Start	
2 <sup>nd</sup>	

180°	CCW ⚙				CW ⌚			
	# 051	# 052	# 053	# 054	# 055	# 056	# 057	# 058
Start								
2 <sup>nd</sup>								
3 <sup>rd</sup>								

360°	CCW ⚙	CW ⌚
	# 059	# 060
Start		
2 <sup>nd</sup>		
3 <sup>rd</sup>		
4 <sup>nd</sup>		

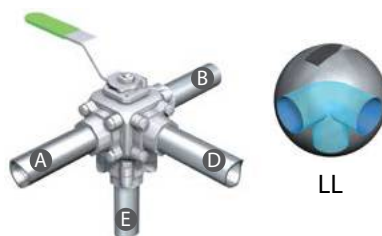



## 4 Way Valve | Bottom Entry D61

90°	CCW ⦿ # 061
Start	
2 <sup>nd</sup>	

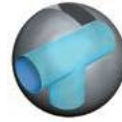
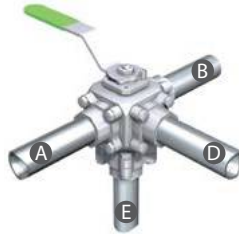

T - Vertical

360°	CCW ⦿	CW ⦿
	# 062	# 063
Start		
2 <sup>nd</sup>		
3 <sup>rd</sup>		
4 <sup>th</sup>		

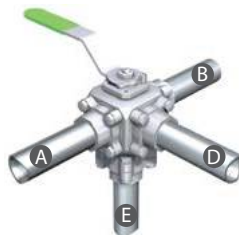

L - Vertical

## 4 Way Valve | Side Entry

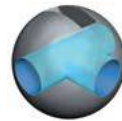
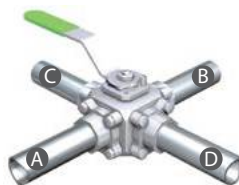

T - Horizontal

90°	CCW ⦿	CW ⦿	180° 2 positions	CW ⦿	180° 3 positions	CCW ⦿	CW ⦿
	# 064	# 065		# 066		# 067	# 068
Start			Start		Start		
2 <sup>nd</sup>			2 <sup>nd</sup>		2 <sup>nd</sup>		
					3 <sup>rd</sup>		

# MULTIPORT FLOATING BALL

## 4 Way Valve | Side Entry

180°	CCW 
	# 069
Start	
2 <sup>nd</sup>	

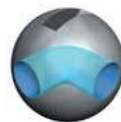
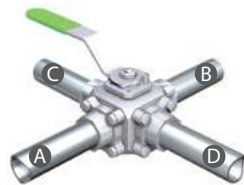

L - Horizontal

360°	CCW 	CW 
	# 070	# 071
Start		
2 <sup>nd</sup>		
3 <sup>nd</sup>		
4 <sup>th</sup>		

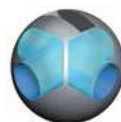
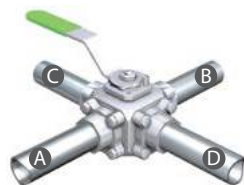

X (LL)

90°	CCW 
	# 072
Start	
2 <sup>nd</sup>	

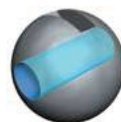
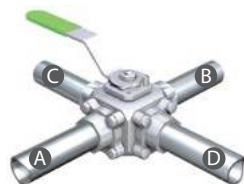

I

90°	CCW 
	# 073
Start	
2 <sup>nd</sup>	

# 5 Way Valve - Bottom Entry D62

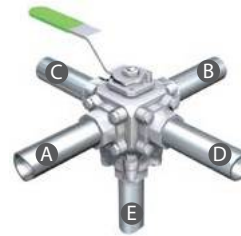

90°	CCW ◯	CW ◯
	# 074	# 075
Start		
2 <sup>nd</sup>		
180°	CCW ◯	CW ◯
	# 076	# 077
Start		
2 <sup>nd</sup>		
3 <sup>rd</sup>		
360°	CCW ◯	CW ◯
	# 078	# 079
Start		
2 <sup>nd</sup>		
3 <sup>rd</sup>		
4 <sup>th</sup>		

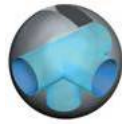

TT - Horizontal

360°	CCW ◯	CW ◯
	# 081	# 082
Start		
2 <sup>nd</sup>		
3 <sup>rd</sup>		
4 <sup>th</sup>		



L - Vertical

90°	CCW ◯
	# 080
Start	
2 <sup>nd</sup>	

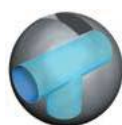

T - Vertical

180° 2 positions	CCW ◯
	# 083
Start	
2 <sup>nd</sup>	

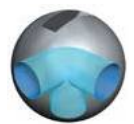

LL

360°	CCW ◯	CW ◯
	# 084	# 085
Start		
2 <sup>nd</sup>		
3 <sup>rd</sup>		
4 <sup>th</sup>		